

Das WALTHER PILOT- Programm

- Hand-Spritzpistolen
- Automatik-Spritzpistolen
- Niederdruck-Spritzpistolen (System HVLP)
- Pulverbeschichtungs-Systeme
- Materialdruckbehälter
- Drucklose Behälter
- Rührwerk-Systeme
- Airless-Geräte und Flüssigkeitspumpen
- Materialumlaufsysteme
- Kombinierte Spritz- und Trockenboxen
- Absaugsysteme mit Trockenabscheidung
- Absaugsysteme mit Naßabscheidung
- Pulversprühstände
- Trockner
- Zuluft-Systeme
- Atemschutzsysteme und Zubehör

The WALTHER PILOT Programme

- Hand-Held Spray Guns
- Automatic Spray Guns
- Low Pressure Spray Guns (System HVLP)
- Powder Coating Systems
- Material Pressure Tanks
- Nonpressurized Tanks
- Agitator Systems
- Airless Equipment and Transfer Pumps
- Material Circulation Systems
- Combined Spraying and Drying Booths
- Spray Booths with Filter Mats
- Spray Booths with Water-Wash Function
- Powder Spray Stands
- Dryers
- Ventilation Systems
- Protective Respiratory Systems and Accessory Items

D

GB



Die Beschichtungs-Experten

WALTHER Spritz- und Lackiersysteme GmbH
Kärntner Str. 18-30 • D-42327 Wuppertal
Tel.: 0202 / 787-0 • Fax: 0202 / 787-217
<http://www.walther-pilot.de>
E-mail: info@walther-pilot.de



EN ISO 9001
QA: 04 1006056

WALTHER PILOT

Betriebsanleitung / Operating Instructions

Automatische Spritzpistolen / Automatic Spray Guns

PILOT WA 560 2-K



Die Beschichtungs-Experten

PILOT WA 560 2-K

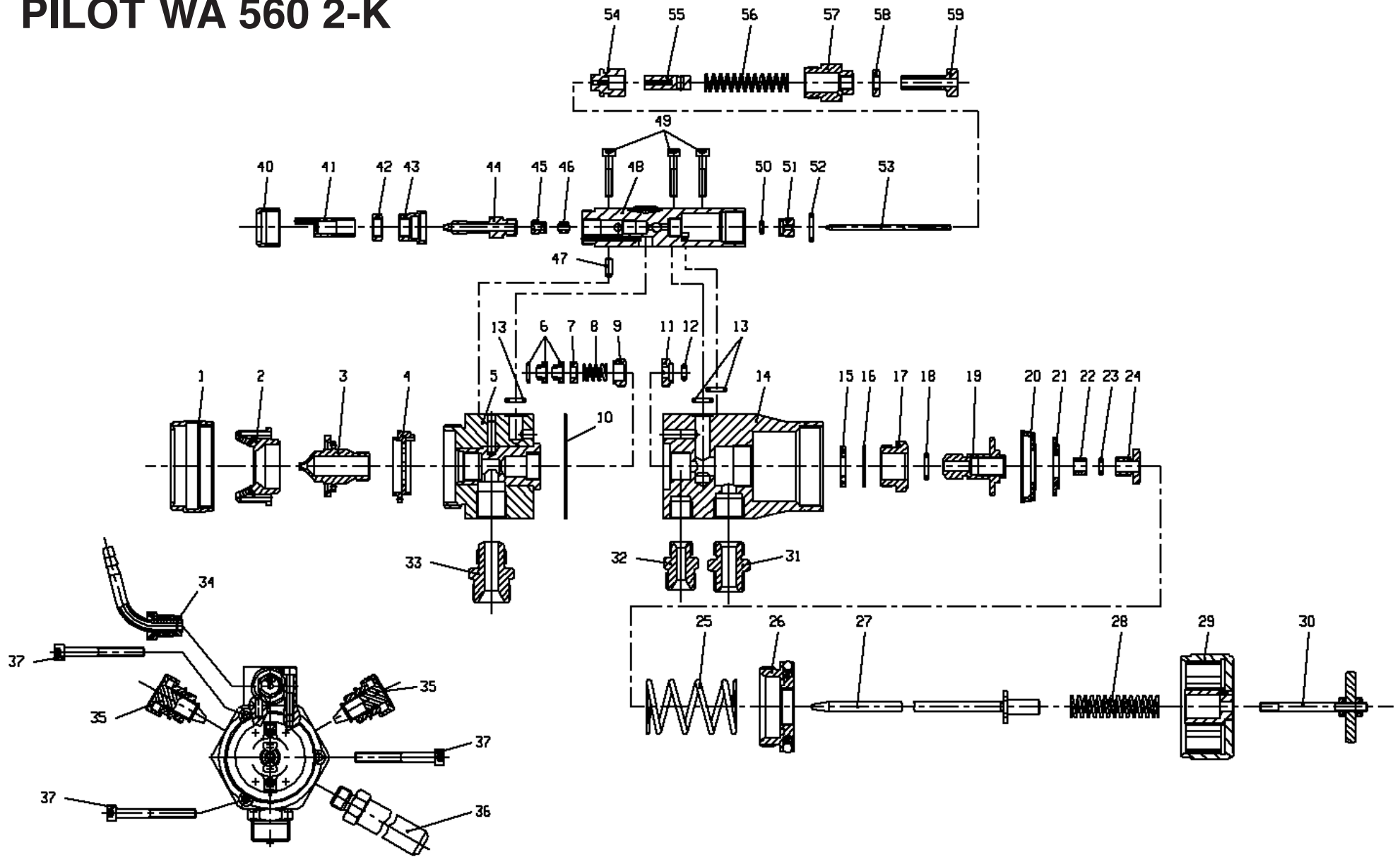

Materialanschluss B-Komp./
Material Connection Comp.-B: G 1/8

Breitstrahlregelung für A-Komp./
Wide/Flat Jet Adjustment for Comp.-A

Einstellschraube B-Komp. /
Adjusting Screw Comp.-B

Materialregelung /
Material Adjustment

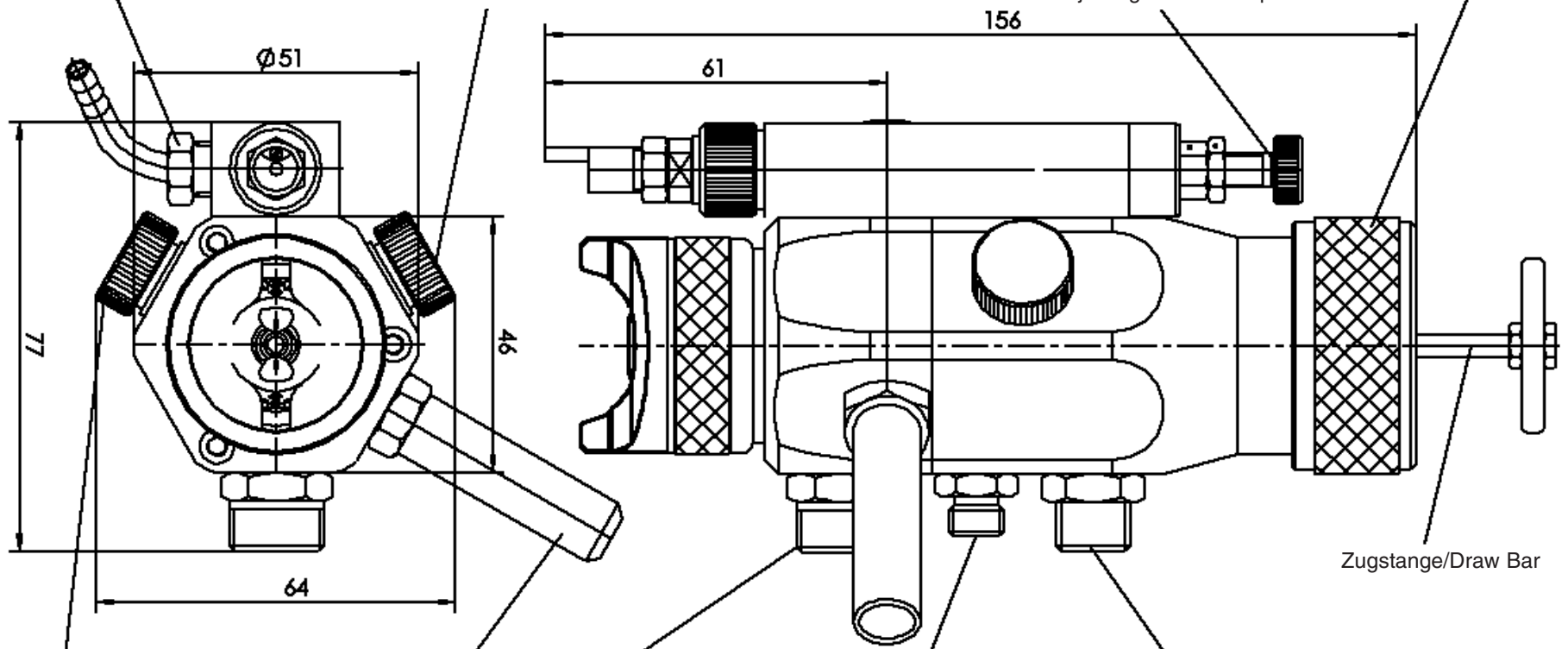

Befestigungsbolzen/Mounting Pin 12 mm \varnothing

Materialanschluss A-Komp./
Material Connection Comp.-A: G 1/8

Zerstäuberluftanschluss A+B-Komp./
Atomizing Air Connection Comp.-A+B: G 1/4

Zugstange/Draw Bar

Rundstrahlregelung für A-Komp./
Round Jet Adjustment for Comp.-A

Steuerluftanschluss A+B-Komp./
Control Air Connection Comp.-A+B: G 1/8

Massblatt / Dimension Sheet WA 560 2-K
V 24 560 00 000

EG-Konformitätserklärung

Wir, der Gerätehersteller, erklären in alleiniger Verantwortung, daß das Produkt in der untenstehenden Beschreibung den einschlägigen grundlegenden Sicherheits- und Gesundheitsanforderungen entspricht. Bei einer nicht mit uns abgestimmten Änderung an dem Gerät oder bei einer unsachgemäßen Verwendung verliert diese Erklärung ihre Gültigkeit.

D

Hersteller	WALTHER Spritz-und Lackiersysteme GmbH Kärntner Str. 18-30 D-42327 Wuppertal Tel.: 0202 / 787-0 Fax: 0202 / 787-217 www.walther-pilot.de • Email: info@walther-pilot.de		
Typenbezeichnung	Automatische Spritzpistole PILOT WA 560 2-K	V 24 560	
Verwendungszweck	Verarbeitung spritzbarer Materialien		
Angewandte Normen und Richtlinien			
EG-Maschinenrichtlinien 98 / 37 EG 94 / 9 EG (ATEX Richtlinien) DIN EN ISO 12100-1 DIN EN ISO 12100-2 EN 1127-1			
Spezifikation im Sinne der Richtlinie 94 / 9 / EG			
Kategorie 2	Gerätebezeichnung	 II 2 G c T 5	Tech.File,Ref.:
Besondere Hinweise : Das Produkt ist zum Einbau in ein anderes Gerät bestimmt. Die Inbetriebnahme ist so lange untersagt, bis die Konformität des Endproduktes mit der Richtlinie 98 / 37 / EG festgestellt ist.			

Wuppertal, den 7. Juli 2003

i.V. 

Name: Torsten Bröker
Stellung im Betrieb: Leiter der Konstruktion und Entwicklung

Diese Erklärung ist keine Zusicherung von Eigenschaften im Sinne der Produkthaftung. Die Sicherheitshinweise der Produktdokumentation sind zu beachten.

Declaration of CE-Conformity

We, the manufacturers of the equipment, hereby declare under our sole responsibility that the product(s) described below conform to the essential safety requirements. This declaration will be rendered invalid if any changes are made to the equipment without prior consultation with us.

GB

Manufacturer	WALTHER Spritz-und Lackiersysteme GmbH Kärntner Str. 18-30 D-42327 Wuppertal Tel.: 0202 / 787-0 Fax: 0202 / 787-217 www.walther-pilot.de • Email: info@walther-pilot.de		
Type Designation	Automatic Spray Gun PILOT WA 560 2-K	V 24 560	
Intended purpose	Processing of sprayable media		
Applied Standards and Directives			
EU-Machinery Directive 98 / 37 CE 94 / 9 EC (ATEX Directives) DIN EN ISO 12100-1 DIN EN ISO 12100-2 EN 1127-1			
Specification according 94 / 9 / CE			
Category 2	Part marking	 II 2 G c T 5	Tech.File,Ref.:
Special remarks : The named product is intended for installation in other equipment. Commissioning is prohibited until such time as the end product has been proved to conform to the provision of the Directives 98 / 37 / CE.			

Wuppertal, the 7th of July 2003

i.V. 

Name: Torsten Bröker
Position: Manager, Design and Development

This Declaration does not give assurance of properties in the sense of product liability. The safety instructions provided in the product documentation must be observed at all times.

**Listing of Replacement Parts:
PILOT WA 560 2-K**

Item No.	Part No.	Description	Item No.	Part No.	Description
1	V 11 360 04 100	Sleeve nut	44	optional V 24 560 22 . . 3*	Material nozzle for nozzle sizes 0.5 - 1.0 mm ø
2	optional V 11 631 12 054* V 11 631 12 204* V 11 631 12 254*	Adhesive-air cap for nozzle sizes 0.8 - 1.0 mm ø 1.2 - 1.8 mm ø 2.0 - 2.5 mm ø	45	V 24 560 05 003	Needle gland
3	optional V 11 641 40 . . 3*	Material nozzle for nozzle sizes 0.8 - 2.5 mm ø	46	V 09 002 34 000	Needle seal packing B-component
4	V 11 601 04 000	Air distribution ring	47	V 20 660 03 000	Lock pin
5	V 24 560 01 003	Front part	48	V 24 560 03 003	Gun body compl.
6	V 09 001 72 000	Needle seal packing A-component	49	V 24 560 06 000	Cylinder head screw
7	V 10 361 07 000	Pressure ring	50	V 09 103 02 000	O-Ring
8	V 20 510 12 003	Packing spring	51	V 20 332 07 000	Seal bushing
9	V 20 510 11 003	Packing screw	52	V 09 103 35 001	O-Ring
10	V 09 001 70 100	Seal	53	optional V 24 560 28 . . 3*	Material needle for nozzle sizes 0.5 - 1.0 mm ø
11	V 20 510 42 003	Sealing screw	54	V 20 332 03 000	Piston
12	V 09 102 02 007	O-Ring	55	V 20 332 05 000	Counter piece
13	V 09 102 21 001	O-Ring	56	V 10 831 04 000	Pressure spring
14	V 24 560 02 000	Piston casing	57	V 24 560 29 005	Spring bushing
15	V 09 230 01 000	Piston casing sealing	58	V 20 336 45 000	Counternut
16	V 09 103 27 001	O-Ring	59	V 24 560 30 005	Adjusting screw
17	V 20 510 24 004	Piston bushing	* Please indicate nozzle size when ordering. We recommend that wearing parts are held on stock. All wearing parts shown in boldface print.		
18	V 09 102 09 001	O-Ring			
19	V 20 510 23 004	Piston			
20	V 20 651 06 000	Cup seal			
21	V 20 510 18 004	Clamping washer			
22	V 20 510 47 004	Piston bushing			
23	V 09 102 02 000	O-Ring			
24	V 20 510 16 004	Piston end nut			
25	V 20 606 11 000	Piston spring			
26	V 20 510 33 000	Threaded bush compl.			
27	optional V 20 570 30 . . 3*	Material needle for nozzle sizes 0.8 - 2.5 mm ø			
28	V 20 510 29 003	Needle spring			
29	V 20 510 32 000	Cap compl.			
30	V 20 510 34 000	Draw bar compl.			
31	V 00 101 01 000	Double nipple			
32	V 00 101 70 000	Double nipple			
33	V 11 611 03 003	Double nipple			
34	V 20 336 31 323	Hose connection compl.			
35	V 11 601 20 000	Round- /flat jet regulation			
36	V 20 510 21 003	Mounting pin			
37	V 20 510 14 003	Cylinder head screw			
40	V 20 332 08 000	Sleeve nut			
41	V 24 560 25 003	Angular jet air cap			
42	V 24 560 24 003	Counternut			
43	V 24 560 26 003	Intermediate piece			

Contents



1	General
1.1	Identification of Model Version
1.2	Normal Use
1.3	Improper Use
2	Technical Description
3	Safety Warnings
3.1	Safety Warning Symbols
3.2	Generally Applicable Safety Precautions
4	Assembly / Installation
4.1	Mounting of Spray Gun
4.2	Connection of Input Lines
5	Operational Handling
5.1	Safety Warnings
5.2	Starting/Stopping Requirements
5.3	Spray Pattern Test
5.4	Spray Pattern Adjustments
5.5	Retooling of Spray Gun
6	Cleaning
6.1	Safety Warnings
6.2	Cleaning - Complete
6.3	Cleaning - Routine
7	Repairs / Replacements
7.1	Replacement of defective Needle Seal Packings -Component A
7.2	Replacement of defective Needle Seal Packings -Component B
7.3	Replacement of Nozzles, Needles, Springs and Seals
8	Trouble shooting and Corrective Action
9	Disposal of Cleaning / Servicing Substances
10	Specification Data

1 General

1.1 Identification of Model Versions

Models: Automatic Spray Gun PILOT WA 560 2-K

Type Series: V 24 560

Manufacturer: WALTHER Spritz- und Lackiersysteme GmbH
Kärntner Str. 18-30
D-42327 Wuppertal (Germany)
Tel.: 0202/787-0
Fax: 0202/787-217
www.walther-pilot.de • Email:info@walther-pilot.de

1.2 Normal Use

The automatic spray gun PILOT WA 560 2-K is exclusively designed for use with sprayable two-component media which are mixed in the external-mix-procedure. All wetted parts are made of stainless steel so as to permit handling of watersoluble and/or aggressive media such as:

- paints and lacquers (after material test)
- adhesive compounds

Should the materials which you want to spray not be listed above, please contact us for further and detailed information.

Please note that sprayable materials may only be applied to work pieces and/or similar items. The temperature of the spraying materials shall never exceed 80 degrees Celsius. The model PILOT WA 560 2-K is not designed for manual operation, and must be installed in a suitable gun mounting device.

The term normal use also implies that any and all safety warnings, operational handling details, etc., as stated in these operating instructions, must be carefully read, understood and duly complied with.

This equipment complies with the explosion protection requirements of Directive 94 / 9 / EC (ATEX 100a) for the explosion group, equipment category and temperature class indicated on the type plate. When using the equipment, the requirements specified in these Operating Instructions must be observed at all times.

The technical data indicated on the equipment rating plates and the specifications in the chapter "Technical Data" must be complied with at all times and must not be exceeded. An overloading of the equipment must be ruled out.

The equipment may be used in potentially explosive atmospheres only with the authorisation of the relevant supervisory authority.

The relevant supervisory authority or the operator of the equipment are responsible for determining the explosion hazard (zone classification).

The operator must check and ensure that all technical data and the marking of the equipment in accordance with ATEX are compliant with the necessary requirements.

The operator must provide corresponding safety measures for all applications in which the breakdown of the equipment might lead to danger to persons.

If any irregularities are observed while the equipment is in operation, the equipment must be put out of operation immediately and WALTHER PILOT must be consulted.

Grounding / Equipotential Bonding

You must ensure that the spray gun is properly earthed (grounded) either separately or in connection with the equipment with which it is being used (maximum resistance 10⁶Ω).

1.3 Improper Use

This spray gun shall not be used for purposes other than set forth in the above Chapter *Normal Use*. Any other form of use and/or application is prohibited.

Improper use is for example:

- spraying of material onto persons and animals
- spraying of liquid nitrogen, etc.

2 Technical Description

The automatic spray guns PILOT WA 560 2-K is all automatic air-controlled gun operating in combination with a 3/2-way control valve. Hand, foot or solenoid-actuated valves can be used.

At first the atomizing air and the control air are opened together in both guns.

Actuation of the 3/2-way valve directs control air into the cylinder inside the gun of component A and B so as to open - in sequence - the atomizing air ducts and the material inputs of both guns. Material emerges from the horns of air cap (Item 2; Component A) as well as from nozzle (Item 55; Component B). Mixing takes place in the spray jet itself.

Closing of the 3/2-way valve is followed by the control air escaping from the cylinder inside both guns, upon which the spring-loaded material needle returns to its initial position, where it shuts the material and atomizing air input off in both guns. The material flow rate and the spray jet contour (flat / wide / round) are adjusted at the gun by way of regulating screws.

The spray guns PILOT WA 560 2-K can be connected to material pressure tanks and pumping systems.

The material inlet duct of PILOT WA 560 2-K can be opened manually so as to permit, for example, cleaning of a clogged material outlet nozzle.

3 Safety Warnings

3.1 Safety Warning Symbols

Warning

This pictograph and the accompanying warning note „Warning“ indicate possible risks and dangers for yourself. Possible consequences: Injuries of any kind.

Caution

This pictograph and the accompanying warning note „Caution“ indicate possible damage to equipment. Possible consequences: Damage to equipment, workpieces, etc.



Notice

This pictograph and the accompanying note „Notice“ indicate additional and useful information to help you handling the spray gun with even greater confidence and efficiency.

3.2 Generally Applicable Safety Precautions

- It is important that all applicable accident prevention directives as well as industrial safety and health rules and regulations are duly complied with.
- Use this spray gun in well ventilated rooms. Open fires, naked lights and smoking are prohibited in the working area. Spraying of readily flammable media such as paints, lacquers, cleaning agents, etc., causes a potential health, explosion and fire risk.
- You must ensure that the spray gun is properly earthed (grounded) either separately or in connection with the equipment with which it is being used (maximum resistance 10⁶ Ω).
- Prior to any servicing and repair work: Make sure that the spray gun is in unpressurized condition, i.e. all air and material inputs must be shut off - if not, imminent risk of injury.
- Keep your hands and other extremities away from the front of the spray gun - imminent risk of injury.
- Never point the spray gun at persons or animals - imminent risk of injury.
- It is important that all processing specifications and safety warnings issued by the manufacturers of spraying and cleaning media are duly complied with. Especially aggressive and corrosive media can cause personal health problems.
- Wear suitable hearing protections while working with the spray gun. Spray guns produce sound levels of up to 86 dB (A), which may cause hearing defects.
- Air-borne particles must be kept away from the working area and personnel. Wear proper respiratory protection masks and protective overalls when working with spraying media. Air-borne particles represent a health hazard.
- Check that nuts and screws are tightened properly after performing servicing and repair work.
- Make sure you use original WALTHER replacement parts designed for functional reliability and efficiency.
- Should you have any questions concerning the safe operation of the spray gun, please contact WALTHER Spritz- und Lackiersysteme GmbH, D-42327 Wuppertal.

4 Assembly / Installation

This spray gun is delivered in completely assembled condition. Before taking the spray gun into operation perform the following preparations:

4.1 Mounting of Spray Gun

Install the gun in a suitable and stable mounting device as shown in the following example:

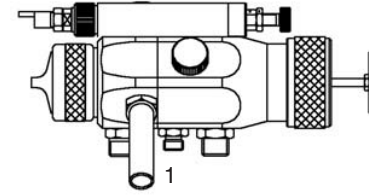

Use mounting pin 1, diameter 12 mm.
Other mounting devices upon request.

4.2 Connection of Input Lines

Warning

Make sure not to confuse the control and atomizing air connections -risk of injury.

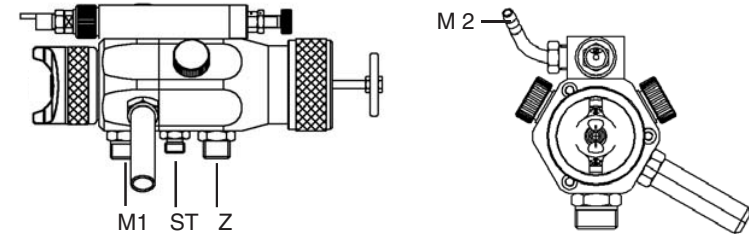

- M1 = Material inlet fitting G 3/8"
- M2 = Material inlet fitting G 1/8" (4 mm hose-diameter)
- ST = Control air inlet fitting G 1/4"
- Z = Atomizing air inlet fitting G 1/4"

The spray gun is now properly installed and connected and ready for operation.

5 Operational Handling

5.1 Safety Warnings

Please pay special attention to the following safety warnings prior to taking this spray gun into operation!

- Wear proper respiratory protection masks and protective overalls, whenever you are operating this spray gun. Air-borne particles represent a health hazard.
- Make sure to wear suitable hearing protectors. The gun produces sound levels of up to 86 dB (A) may cause hearing defects.
- Open fires, naked lights and smoking prohibited in the working area. Spraying of readily flammable media such as paints and adhesive compounds is always accompanied by the risk of fire and explosion.

5.2 Starting / Stopping Requirements

The following requirements must be met before taking this spray gun into operation:

- control air must be available at the gun.
- atomizing air must be available at the gun.
- material pressure for component A and component B must be available at the gun.
- the horns of the adhesive-air cap and the angular jet air cap have to be in the same axis.

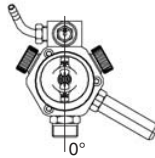

Caution

The material pressure shall not exceed

- 10 bar for component A,
- 6 bar for component B,

as, otherwise, the functional reliability of the spray gun will suffer.

Adjust the control air pressure to

- at least 4 bar, in order to operate the spray gun.

The operation of the spray gun can be started/stopped by way of the 3/2-way control valve (see the Operating Instructions of the plant systems manufacturer).

Warning

It is important to remember that the spray gun must be relieved of all pressures whenever work is terminated. Lines left in pressurized condition could burst, with their contents likely to injure anybody present nearby.

5.3 Spray Pattern Test

Spray pattern tests should be performed whenever:

- the spray gun is taken into operation for the first time.
- the spraying medium is changed.
- the spray gun was taken apart for servicing or repairs.

The spray pattern can be tested using a work piece sample, a sheet of metal, cardboard or paper.

Warning

Keep away from the front of the spray gun - imminent risk of injury.

Warning

Make sure that nobody is present in the spraying zone when the gun is started - imminent Risk of Injury.

1. Start the gun to produce a spray pattern sample (see 5.2. *Starting/Stopping Requirements*).
2. Inspect the sample and readjust the settings of the gun as may be required (see 5.4 *Spray Pattern Adjustments*).

5.4 Spray Pattern Adjustments

The spray pattern of the PILOT WA 560 2-K can be adjusted as follows:

Adjusting the jet pattern

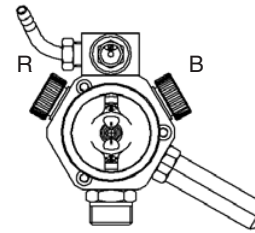

An optimum spray pattern can be adjusted by using control screws R and B. The control screw R regulates the round jet, the control screw B the wide/flat jet.

Adjustment of the material flow rate

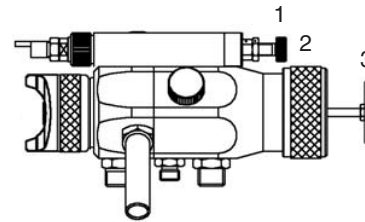

The material flow rate for the component B can be adjusted by turning the adjusting screw 1.

Turn cap 2 from the standard position (= notch mark on the piston housing)

- to the inside in order to decrease the material flow rate.
- to the outside in order to increase the material flow rate.

The material flow through the nozzle can be performed without using atomizing air, when the drawbar 3 is used.

Adjustment of the Material Pressure

This adjustment can only be made at the controls of the pump or the material pressure tank. Please comply with the operating instructions and safety warnings issued by the manufacturers concerned.

Adjustment of the Atomizing Air Pressure







The atomizing air pressure is adjusted at the air pressure reducing valve of the compressor system. Please comply with the operating instructions and safety warnings issued by the manufacturer.

If you wish to change the spraying pattern beyond the adjustments outlined so far, you must retool the spray gun. (see 5.5 *Retooling of Spray Gun*). WALTHER offers a great variety of air cap/-material nozzle/needle combinations for this purpose.

Correcting of Spray Pattern Imperfections

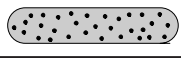
The following table shows what to do to correct a spray pattern.

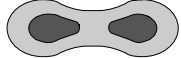
 desireable spray-painting result

Spray pattern test	Fault	Necessary adjustment
	Swollen centre	• Spray jet should be flatter
	Swollen ends	• Spray jet should be rounder
	Coarse pearl effect	• Increase atomising air pressure
	Unduly thin paint layer in centre	• Decrease atomising air pressure
	Split centre	• Increase nozzle diameter • Reduce atomising air pressure • Increase material pressure
	Split centre	• Decrease material pressure • Increase atomising air pressure

5.5 Retooling of Spray Gun

Combinations of air cap, material nozzle and needle, designed to match specific spraying media types and grades, form a unit - namely the nozzle insert assembly. In order maintain the desired spray-finish quality standard always replace the complete nozzle insert assembly.

Warning

Prior to retooling: Make sure that the spray gun is in unpressurized condition, i.e. all air and material inputs must be shut off - if not, imminent risk of injury.



Note

In order to perform the following procedures please use the drawing at the beginning of these operating instructions.



Note

When mounting the nozzle, the material needle should be in a flashed condition.

Replacement of Air Cap -Component A

1. Unscrew the knurled sleeve nut (Item 1) from the front part (item 5).
2. Pull the air cap in (Item 2) of the front part.
3. Position the required air cap on the front part.
4. Screw the sleeve nut onto the front part.

Replacement of Air Cap -Component B

1. Unscrew the knurled sleeve nut (Item 40) from the gun body (item 48).
2. Pull the angular jet air cap (Item 41) with the counternut (item 42) and the intermediate piece (item 43) of the gun body.
3. Unscrew the angular jet air cap with the counternut from the intermediate piece and position the required air cap in the intermediate piece. Secured the required position of the air cap with the counternut.

Installation of the remaining parts is performed in the reverse order.

Replacement of Material Nozzle and Needle -Component A

1. Remove the air cap (see *Replacement of Air Cap -Component A*).
2. Unscrew the material nozzle (Item 3) from the front part.
3. Unscrew the cap (Item 29) from the threaded bush (Item 33).
4. Pull off the material needle (Item 27) from the piston casing (item 14).
5. Unscrew the material needle of the draw bar (Item 30).

Installation of the new nozzle insert assembly and the remaining parts is performed in the reverse order.

Replacement of Material Nozzle and Needle -Component B

1. Remove the air cap (see *Replacement of Air Cap -Component B*).
 2. Unscrew the material nozzle (Item 44) from the gun body.
 3. Remove the spring bushing (item 57) with the pressure spring (Item 56) from the gun body.
 4. Pull off the material needle (Item 53) with the counter piece (item 55) from the gun body (item 14).
 5. Unscrew the material needle of the counter piece.
- Installation of the new nozzle insert assembly and the remaining parts is performed in the reverse order. The distance between the tip of the material needle and the counter piece is 70,5 m.

6 Cleaning

6.1 Safety Warnings

- Prior to any servicing and repair work: Make sure that the spray gun is in unpressurized condition, i.e. all air and material inputs must be shut off - if not, imminent risk of injury.
- No open fires, naked light and smoking allowed in the work area. When spraying readily flammable media such as cleaning solutions, there is an increased risk of fire and explosion.
- Observe the safety warnings issued by the manufacturer. Aggressive and corrosive media represent risks and hazards to personal health.

6.2 Cleaning - Complete

Regular cleaning and lubrication of the spray gun has to be performed, in order to increase the service life and the function of the spray gun.

Clean the gun only with cleaning solutions recommended by the manufacturer of the spraying material used at the time. It is important to make sure that cleaning solutions do not contain any of the following constituents:

- halogenated hydrocarbons
(e.g. 1,1,1-trichloroethane, methylene chloride, etc.)
- acids and acidiferous cleaning solutions
- regenerated solvents (so-called cleaning dilutions)
- paint removers.

The above constituents cause chemical reactions with the electroplated components resulting in corrosion damage.

WALTHER PILOT is not responsible for any damages resulting from such treatment.

Clean the spray gun

- prior to each change of the spraying medium
- at least once a week
- as often as may be required by the spraying medium handled and the resultant degree of fouling.

Caution

Never immerse the spray gun in solvent or any other cleaning solution. The functional reliability and efficiency of the gun can otherwise not be guaranteed.

Caution

Do not use any hard, pointed or sharp-edged objects when cleaning the spray gun. Any damage of the precision-made parts are likely to affect your spraying results.

1. Dismantle the spray gun in accordance with 5.5 *Replacement of Material Nozzle and Needle*.
2. Use a soft brush together with a compatible cleaning solution to clean the air cap and nozzle.
3. Clean the remaining parts and the spray gun body with a suitable cloth and cleaning solution.
4. Apply a thin film of the appropriate grease to the:
 - sealing collar of the piston
 - O-ring of the piston
 - material needle
 - needle spring

Make sure to use a non-acidic, non-resinogenic grease and a soft brush. The spray gun is then reassembled in reverse order.

6.3 Cleaning - Routine

The spray gun need not necessarily be dismantled for cleaning if and when the spraying medium is changed in regular intervals or upon termination of work (depending on the material used).



Note

Clean and lubricate the spray gun frequently in accordance with Chapter 6.2 *Cleaning - Complete*. This will ensure functional reliability of the spray gun.

The following requirements must be met before the routine cleaning work can be performed:

1. The material tank must be cleaned and then be filled with a compatible cleaning solution. Material pressure has to be available at the spray gun. The cleaning solution should not be sprayed.
2. Take the spray gun into operation (see 5.2 *Starting the Spray Gun*).
3. Do not stop the spray gun until clear cleaning solution emerges from the nozzle.

The material supply of the PILOT WA 560 2-K can be manually released so that it is not necessary to operate the complete spraying system.

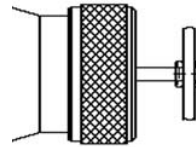

1. Pull back the draw bar of the spray gun. The material inlet is now open and both the material control needle will be cleaned.
2. Do not let go of the drawbar until clear cleaning solution emerges from the nozzle.

All pressures should then be removed from the complete spraying system until the next operation.

7 Repairs / Replacements

Warning

Prior to any repairs / replacements: Make sure that the spray gun is in unpressurized condition, i.e. all air and material inputs must be shut off - if not, imminent risk of injury.



Note

Please use the drawing at the beginning of these operating instructions to perform the following procedures.

7.1 Replacement of defective Needle Seal Packings-Component A

1. Remove the material needle see 5.5 *Retooling the spray gun*.
2. Unscrew by loosening the 3 cylinder head screws (Item 49) the gun of the component B from the gun component A.

3. Unscrew the 3 mounting screws (Item 6) from the front part in (Item 5) (width over flats of hex. nut 3).
 4. Pull the front part off the piston casing in (Item 14).
 5. Remove the sealing (item 10).
 6. Unscrew the packing screw (item 9) from the front part in (screw driver).
 7. Remove the packing spring (Item 8) (replace, if damaged) and the pressure ring in (Item 7) from the threaded socket.
 8. Pull out the needle seal packing (Item 6) with an auxiliary tool. Use a strong wire on which one end is bent making a small hook.
 9. Lubricate the new needle seal packing with non-acidic, non-resinogenic grease.
 10. Install the new needle seal packing in the front part.
- Installation of the remaining parts is performed in reverse order.



Note

Never reinstall a used needle seal packing as otherwise the functional sealing reliability of the spray gun will suffer.

7.1 Replacement of defective Needle Seal Packings-Component B

1. Remove the material needle see 5.5 *Retooling the spray gun*.
 2. Unscrew the the needle gland (item 45) from the gun body (item 48) (screw driver).
 3. Pull out the needle seal packing (Item 6) with an auxiliary tool. Use a strong wire on which one end is bent making a small hook.
 4. Lubricate the new needle seal packing with non-acidic, non-resinogenic grease.
 5. Install the new needle seal packing in the front part.
- Installation of the remaining parts is performed in reverse order.



Note

Never reinstall a used needle seal packing as otherwise the functional sealing reliability of the spray gun will suffer.

7.3 Replacement of Nozzles, Needles, Springs and Seals

Dismantle the spray gun in accordance with Chapter 7.2 *Repalcement of Material Nozzle and Needle*, if the following components have to be replaced:

- material nozzle
- piston spring
- material needle*
- needle spring*
- piston sealing collar*
- piston O-ring*

Note

Parts marked with * must be lubricated with non-acidic, non-resinogenic grease prior to installation. Wearing parts are also shown in the listing of replacement parts (in bold face).

8 Troubleshooting and Corrective Action

Warning

Prior to any servicing and repair work: Make sure that the spray gun is in unpressurized condition, i.e. all air and material inputs must be shut off - if not, imminent Risk of Injury.

Fault	Cause	Corrective Action
Gun is dripping	Material control nozzle or needle fouled	see 5.5 <i>Removing Material Control Nozzle or Needle and cleaning</i>
	Material control nozzle or needle damaged	see 7.2 <i>Replacing Material Control Nozzle or Needle</i>
	Packing gland too tight	Loosen packing screw in (Item 12) slightly with a screw driver
Gun fails to open	Control air pressure too low	Increase control air pressure to at least 4,5 bar
Material leaks from leakage boring	Needle seal packing leaks	see 7.1 <i>Replacing Needle Seal Packing</i>
	Packing gland too loose	Tighten packing screw in (Item 12) slightly with a screwdriver
Spray jet pulsating or unsteady	Level in material tank too low	Top-up material level (see operating instructions of plant systems manufacturer)
No mixture between the 2 components	Horns of adhesive-air cap are not in the same axis to the angular jet air cap	Correct the position of the horns see 5.2 Starting Requirements

9 Disposal of Cleaning / Servicing Substances

Disposal of any such substances must be in accordance with all applicable local and national regulations, directives and laws.

Warning

Pay special attention to all processing specifications and safety warnings issued by the manufacturers of spraying and cleaning media. The improper disposal of any toxic waste material represents a serious threat to the environment, i.e. to the health of mankind and animal life.

10 Specification Data

Weight: 1260 g

Nozzle Sizes: 0.8 • 1.0 • 1.2 • 1.4 • 1.5 • 1.8 • 2.0 • 2.2 • 2.5 mm ø

Connections:

Atomizing Air	G 1/4 inch
Control Air	G 1/4 inch
Material Inlet Component A	G 3/8 inch
Material Inlet Component B	G 1/8 inch

Pressure Ranges:

Control Air Pressure	min. 4 bar
Material pressure Component A	max. 10 bar
Material pressure Component B	max. 6 bar
Atomizing Air	max. 8 bar

max. Operating

Temperature of Spray gun	80 degs. C
--------------------------	------------

Sound Level

(measured at a distance of 1m from the spray gun)	86 dB (A)
---	-----------

Right to effect technical changes reserved.